



EVERYONE IS LOOKING FOR AN OPPORTUNITY



प्रत्येक व्यक्ति एक अवसर की तलाश में हैं ।

DIRECTORS VIEW

1. The Directors of the Company always Respect of India, Government of India & States.
2. They also believe in the Laws of India and states. Further, the company is always ready for each and every compliance of Applicable laws in India and States.
3. The Directors of the company is also rely on the following principles/Concepts.
 - a) **OUR NATION FIRST**
 - b) **CONSUMER SATISFACTION** – By way of providing Good quality Product and quality services to consumer 24*7.
 - c) **DIRECT SELLERS GROWTH**

With one vision that “the growth of the company is always depends upon the Growth of Direct sellers and happiness of Consumers”

ABOUT THE PRODUCTS OF THE COMPANY

1. We have taken immense pleasure in introducing first ever Retail concept with maximum benefit for customers.
2. Our company is manufacturing of various Herbal Products, Food products, spices, toiletries, wellness products, beauty products, Dietary supplements, Nutraceuticals and Health products with Best quality & original ingredients.
3. Further the company is having own in-house Research and development, to provide the quality products to consumers.
4. Further our company is looking for new development/planning to provide Enriched healthy wealthy Products to our most valuable consumers and Direct sellers.
5. For smooth delivery, the company has opened own warehouse at each state level.

KEY NOTES ABOUT THE COMPANY

1. **Asclepius wellness private Limited**, a Company incorporated under the Companies Act, 2013 , having its Registration No. **CIN- U51909DL2014PTC272296** and Registered Office at **Plot No. 18, Pocket-8, Block-C, Near HDFC Bank, Sector-17, Dwarka, New Delhi -110075** hereinafter referred to as the Company.
2. The Company is engaged into the business of direct selling through its Direct Seller and Retail Outlets as stated in the Object Clauses of memorandum of Association of the Company.
3. The company having own trademark for company's manufactured Products, GST, Income Tax, TDS and other license as may be required as per the law/regulation/Guideline of its principle place of Business and GST and other license for each retail outlets at various states in India.
4. The company is also having own trademark to promote the products for sale/ direct selling business and trademark identifies the company with the goods to be sold or supplied.
5. Our company is engaged in the Business of Direct selling. Direct selling refers to selling products directly to the consumer in a non-retail environment. Instead, sales occur at home, work, or other non-store location. This system often eliminates several of the middlemen involved in product distribution, such as the regional distribution center and wholesaler. Instead, products go from manufacturer to the direct sales company, to the distributor or rep, and to the consumer.
6. The products sold through direct sales are usually not found in typical retail locations, which means finding a distributor or rep is the only method to buy the products or services.
7. All the sales was done by through its sales agent i.e Direct sellers and middleman commission was given to the Direct sellers/sales agent during the considering year.
8. For smooth running the business of direct selling, Company has certain rules and regulation, marketing plan and other terms and conditions. Now in order to simplify more, to keep more transparent, to control the fraudulent practices and for betterment of the activities of direct selling through multilevel marketing, Company is using better trading plan and marketing plan to promote the sale of the company's products.
9. The Company exclusively uses their website and Retail Outlet to display the details about products, products information, product quality certificate, price, complete income plan, marketing methods, business monitoring, information regarding management while uses the word of mouth publicity to promote and create awareness about the website and its products.

Registration with Ministry of Consumer affairs

In respect of compliance of Guideline on Direct selling issued by the Department of consumer Affairs, Ministry of Consumer Affairs, Food & Public Distribution, we have already submitted the document, in respect of which we have been received the receiving **Letter No. 21/49/2016-IT from Department of consumer affairs dated:16/12/2017** and our company's name is also published and listed in Department's list" **List of Direct Selling Entities "**which was published by the Department on 31/10/2018.

Furthermore, the company is also registered with the ministry of consumer affairs of the following states whose Direct selling Guidelines issued.

S.No.	Name of state	Guideline issued on	Date of Registration	Ministry
1	Delhi	26-10-2016	16-12-2016	Government Of India, Ministry Of Consumer Affairs, Food And Public Distribution, Department Of Consumer Affairs, New Delhi
2	Chhattisgarh	09-10-2017	11-04-2018	Ministry Of Consumer Affairs, Food & Public Distribution
3	Odisha	05-02-2018	26-04-2018	Government Of Odisha State - Department Of Consumers Affairs
4	Rajasthan	07-08-2018	27-09-2018	Government Of Rajasthan State - Department Of Consumers Affairs
5	West Bengal	05-07-2018	30-10-2018	Government Of West Bengal - Department Of Consumers Affairs
6	Maharashtra	10-07-2019	04-08-2019	Food, Civil Supply And Consumer Protection Department
7	Himachal Pradesh	24-07-2019	13-01-2021	Food, Civil Supplies And Consumer Affairs Department
8	Punjab	30-10-2020	13-01-2021	Department Of Food, Civil Supplies And Consumer Affairs
9	Tamil Nadu	31-10-2018	04-02-2021	Co-Operation, Food And Consumer Protection Department
10	Andhra Pradesh	11-12-2017	05-02-2021	Consumer Affairs, Food & Civil Supplies (Cs-li) Department
11	Goa	06-12-2018	23-02-2021	Department Of Civil Supplies And Consumer Affairs
12	Telangana	01-12-2017	23-02-2021	Ministry Of Consumer Affairs, Food & Public Distribution, Department Of Food & Public Distribution,
13	Sikkim	24-10-2017	25-02-2021	Government Of Sikkim Legal Metrology Unit And Consumer Protection Food & Civil Supplies And Consumer Affairs Department
14	Mizoram	20-07-2017	25-02-2021	Govt. Of Mizoram, Commerce & Industries Department

Who can start own Business as Direct selling Agent with Asclepius wellness Private Limited

1. An Individual/Firm/Company who is able to do contract as per the provision of The Indian Contract Act, 1872 and wish to become direct seller of the company, may apply to be appointed as a Direct seller to marketing and selling of company's product in whole of India, in prescribed form through online/manual.
2. There is **NO deposit or any charges/enrollment fees/joining fees/renewal charges** for becoming a Direct Seller of the Company.

CONCEPT OF DIRECT SELLING

1. Our company is engaged in the Business of Direct selling. Direct selling refers to selling products directly to the consumer in a non-retail environment. Instead, sales occur at home, work, or other non-store location. This system often eliminates several of the middlemen involved in product distribution, such as the regional distribution center and wholesaler. Instead, products go from manufacturer to the direct sales company, to the distributor or rep, and to the consumer.
2. The products sold through direct sales are usually not found in typical retail locations, which means finding a distributor or rep is the only method to buy the products or services.
3. **All the sales was done by/through its sales agent i.e. Direct sellers and middleman commission was given to the Direct sellers/sales agent during the considering year. This is the basics reason of the distribution of large/huge commission to the direct sellers.**

KEY BENEFITS OF OUR CONCEPT AND MATHEMATICALLY CALCULATED BUSINESS PLAN

1. To Direct support to self corresponding organization.
2. To clarify and explain the commission on calculation basis with mathematically manner.
3. To distribute the Sales Commission on the basis of achieved sales goal to Direct Sellers.
4. All Sales Commissions exclusively depends upon product purchase/ sale by direct sellers and corresponding organizations.
5. No condition on limit of Direct sellers.
6. No joining/enrolment/registration fees to become Direct seller
7. No commission payment is paid on recruitment basis to Direct sellers
8. Mathematically calculated Business Plan
9. Only purchase/sale of products is first and last option to boost/earn commissions by Direct sellers.
10. No kit or joining fees: To earn sales commission purchases/sale of any product which is Having Sales point and these sales point is the base for entitlement of sales commission.
11. Direct seller platform is exclusively opened for consumers.
12. Direct seller – means the Direct selling agent who work independently as own business.

HOW TO BECOME A DIRECT SELLER

1. Free Registration
2. Register through our website : www.asclepiuswellness.com
3. Update KYC
4. Go through terms & conditions, agree & put signature through O.T.P.
5. You will get your user ID & password instantly.

After registration anyone can start Business with Asclepius Wellness by simply purchasing products as per their choice & needs as Direct Sellers

DIRECT SELLER BENEFITS

S.NO	CATEGORY	BENEFITS FOR DIRECT SELLERS
1.	Self Purchase from 1 to 26 SP	<ul style="list-style-type: none">▪ Life time retail discount 5% to 30% on every products of company
2.	Self purchase Sales Point accumulated to 27 SP to 51 SP.	<ul style="list-style-type: none">▪ Eligible for Sales Commission.▪ Eligible for Monthly Sales Performance Commission.▪ Eligible for Star Sales Leadership Commission.▪ Eligible for Ambassador Club Leadership Commission.▪ Eligible for 3rd & Above Direct Leg Sales Commission.▪ Eligible for Preferred Customer Sales Commission.
3.	Self purchase Sales Point accumulated to 52 SP to 99 SP.	<ul style="list-style-type: none">▪ Eligible for Sales Commission.▪ Eligible for Monthly Sales Performance Commission.▪ Eligible for Star Sales Leadership Commission.▪ Eligible for Ambassador Club Leadership Commission.▪ Eligible for 3rd & Above Direct Leg Sales Commission.▪ Eligible for Preferred Customer Sales Commission.
4.	Self purchase Sales Point accumulated to 100 SP & above.	<ul style="list-style-type: none">▪ Eligible for Sales Commission.▪ Eligible for Monthly Sales Performance Commission.▪ Eligible for Star Sales Leadership Commission.▪ Eligible for Ambassador Club Leadership Commission.▪ Eligible for Premium Star Sales Performance Commission.▪ Eligible for 3rd & Above Direct Leg Sales Commission.▪ Eligible for Preferred Customer Sales Commission.

7 – Type of Sales Commission

Company is providing pure Sales Commission on the basis of product purchase/sale by Direct Sellers & their Corresponding Organizations as mentioned below :-

1. SALES GROWTH COMMISSION.
2. MONTHLY SALES PERFORMANCE COMMISSION.
3. STAR SALES LEADERSHIP COMMISSION.
4. AMBASSADOR CLUB LEADERSHIP COMMISSION.
5. PREMIUM STAR SALES PERFORMANCE COMMISSION.
6. 3RD AND ABOVE DIRECT LEG SALES INCENTIVE.
7. PREFERRED CUSTOMER SALES COMMISSION.

Kindly note that

1. SP means, described sales point which has been **assigned** to the products of company.
2. Company is providing pure **sales** commission on behalf of the purchase/sale of products by direct sellers only.
3. Total equivalent SP generated in corresponding organizations with 50 SP is called cycle.
4. Premium Star Direct Seller Means: One who qualifies the maximum eligible sales Growth commission from corresponding sales organizations with equivalent 15000 SP.

A. SALES GROWTH COMMISSION

The company shall provide **Sales Growth Commission** as Rs.45 for each 1 SP on the achievement of specified purchase/sale by the direct seller in corresponding organizations as mentioned below -

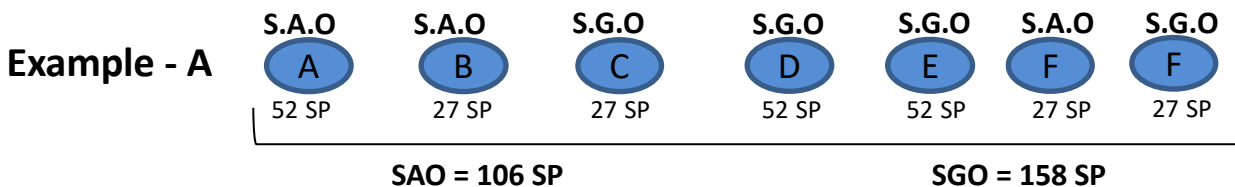

Total S.A.O Sales Point = 106 SP

Total S.G.O Sales Point = 158 SP

Equivalent ORGANIZATIONS S.P of A = 100 ,

**Non Equivalent ORGANIZATIONS Balance
SP will be count in next week business**

**: S.A.O = 6 SP
S.G.O = 58 SP**

Example - B

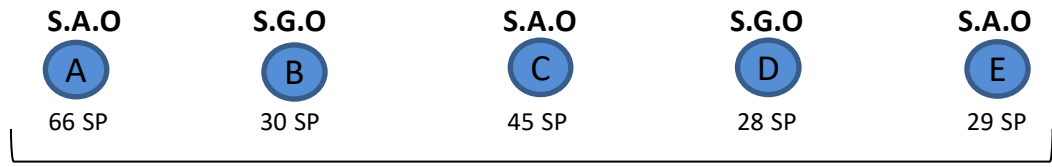

SAO = 140 SP

SGO = 58 SP

Total S.A.O Sales Point = 140 SP
 Total S.G.O Sales Point = 58 SP

**Equivalent ORGANIZATIONS S.P of B = 50 ,
 Non Equivalent ORGANIZATIONS Balance SP : S.A.O = 90
 SP will be counted in next week business
 S.G.O = 8 SP**

FORMULA FOR CALCULATION OF SALES GROWTH COMMISSION

(SGCR) Sales Growth Commission Rate = $\frac{\text{Total S.P Of Company in that week} \times \text{Rs. 45}}{\text{Total Equivalent S.P cycle of company in that week}}$

- **Total S.P of Company means** = Total sales point in respect of overall turnover of the company in that week.
- **Total Equivalent S.P cycle of company means** = Total equivalent SP generated in corresponding organizations with 50 SP is called a cycle.

FOR Example :

From Above mentioned Diagrams:- **A EQUIVALENT ORGANIZATIONS SP = 100SP**
B EQUIVALENT ORGANIZATIONS SP = 50 SP

Example -1

Example -2

Total S.P turnover in that week = 500000 SP
 SALES growth COMMISSION will be = Rs.45.00 per S.P
 500000 SP x Rs.45.00 = Rs.2,25,00,000.00
 Total equivalent S.P cycle of company in that week = 45200
 $\frac{\text{Rs.2,25,00,000}}{45200} = \text{Rs. 497.78}$
 To get SGCR for per SP = $\frac{\text{Rs.497.78}}{50 \text{ SP}} = \text{Rs. 9.95 (SGCR)}$

Total S.P turnover in that week = 500000 SP
 SALES growth COMMISSION will be = Rs. 45.00 per SP
 500000 SP x Rs.45.00 = Rs.2,25,00,000.00
 Total equivalent S.P cycle of company in that week = 43000
 $\frac{\text{Rs.2,25,00,000}}{43000} = \text{Rs.523.25}$
 To get SGCR for per SP = $\frac{\text{Rs.523.25}}{50 \text{ SP}} = \text{Rs. 10.46 (SGCR)}$

From Above calculation, 9.95/- is SALES GROWTH COMMISSION RATE.
 Maximum value of 1 SP is Rs.10/- or actual SGCR, whichever is lower.

From above calculation, Rs.10.46 is SALES GROWTH COMMISSION RATE.
 Maximum value of 1 SP is Rs.10/- or actual SGCR, whichever is lower.

For **A** :- SGC is = 100 SP x 9.95 = Rs. 995.00

For **A** :- SGC is = 100 SP x 10 = Rs.1000.00

For **B** :- SGC is = 50 SP x 9.95 = Rs. 497.50

For **B**, SGC is = 50 SP x 10 = Rs. 500.00

- NOTE :**
- ✓ **Maximum value of 1 SP is Rs.10/- or actual SGCR, whichever is lower.**
 - ✓ **Direct sellers will be eligible to get commission when Direct Sellers purchase/sale product of 100 SP in any one organization & 50 SP in another corresponding Organization.**

Kindly note that

1. **Maximum value of 1 SP is Rs.10/- or actual SCR, whichever is lower.**
2. **Minimum Sales Growth Commission shall be Rs.500 on minimum equivalent 50 SP in corresponding organization.**
3. **Direct Seller will be eligible to get commission when Direct Seller purchase/sale product of 100 SP in any one organization & 50 SP in another corresponding organization. Then Direct Seller will be eligible for 1st Sales Growth Commission of Rs.500.**
4. For such SALES GROWTH COMMISSION, every Direct seller shall be authorized to create unlimited Sales Achievement Organization or Sales Generation Organization, depends upon the own skill and expertise of the Direct seller.
5. Sales Growth Commission shall be paid to the Direct sellers on their achieved equivalent sales point from corresponding organizations as the result of product purchased/sale by the own Direct and Indirect sales organization.
6. For such Commission, Every Direct seller may engage unlimited directs in own sales team as Direct seller to promote sales of the company in corresponding organizations.
7. Direct seller shall promote, trained, develop expertise to direct sellers who are under own corresponding ORGANIZATIONS to create/explore maximum sales of product in the company.
8. Direct seller may guide, help, promote, Train to achieve sales point criteria to all direct sellers who are under his own corresponding organizations.
9. To maintain & get such Sales Growth Commission on regular basis every direct seller have to make self Purchase of 5 SP from 1st to 5th Rank ,15 SP from 6th to 8th & 45 SP from 9th to 18th rank Direct Sellers.

MAXIMUM ELIGIBLE SALES GROWTH COMMISSION LIMIT

TABLE – A

Category of DS	(Sales Point) through self purchase	Initial weekly Maximum Eligibility in respect of the commission (In Rs.)	Equivalent SP
Executive Direct Seller	Self purchase Sales Point accumulated to 27 SP to 51 SP.	Rs. 50,000.00	5000 SP
Super Direct Seller	Self purchase Sales Point accumulated to 52 SP to 99 SP.	Rs. 1,00,000.00	10000 SP
Premium Direct Seller	Self purchase Sales Point accumulated to 100 SP & above.	Rs. 1,50,000.00	15000 SP

NOTE - Every Direct seller can update his/her direct seller code as per their own choice from above mentioned Categories. Option for update direct seller code is given in user login panel.

Increase your weekly Maximum Eligible Commission limit by Rs. 25,000/- each 3rd to 7th Direct

1. When anyone from your 3rd to 7th direct or anyone from his corresponding organizations (SAO & SGO) will achieve 15000 SP **ORGANIZATIONS** equivalent in that week.

Any 3 rd Direct self or anyone from his corresponding organizations (SAO & SGO) will achieve 15000 SP in SAO & 15000 SP in SGO.	Rs.25000/- will add to current Maximum Eligible Commission
Any 4 th Direct self or anyone from his corresponding organizations (SAO & SGO) will achieve 15000 SP in SAO & 15000 SP in SGO	Rs.25000/- will add to current Maximum Eligible Commission
Any 5 th Direct self or anyone from his corresponding organizations (SAO & SGO) will achieve 15000 SP in SAO & 15000 SP in SGO	Rs.25000/- will add to current Maximum Eligible Commission
Any 6 th Direct self or anyone from his corresponding organizations (SAO & SGO) will achieve 15000 SP in SAO & 15000 SP in SGO	Rs.25000/- will add to current Maximum Eligible Commission
Any 7 th Direct self or anyone from his corresponding organizations (SAO & SGO) will achieve 15000 SP in SAO & 15000 SP in SGO	Rs.25000/- will add to current Maximum Eligible Commission

Maximum Eligible Commission will increase up to Rs.1,25,000/- from 3rd to 7th Direct.

Increase your weekly Maximum Eligible Commission by Rs. 50,000/- each from 8th to 10th Direct

1. When anyone from your 8th to 10th direct or anyone from his corresponding organizations (SAO & SGO) will achieve 15000 SP **ORGANIZATIONS** equivalent in that week.

Any 8th Direct self or anyone from his corresponding organizations (SAO & SGO) will achieve 15000 SP in SAO & 15000 SP in SGO	Rs.50000/- will add to current Maximum Eligible Commission
Any 9th Direct self or anyone from his corresponding organizations (SAO & SGO) will achieve 15000 SP in SAO & 15000 SP in SGO	Rs.50000/- will add to current Maximum Eligible Commission
Any 10th Direct self or anyone from his corresponding organizations (SAO & SGO) will achieve 15000 SP in SAO & 15000 SP in SGO	Rs.50000/- will add to current Maximum Eligible Commission

Maximum Eligible Commission will increase up to Rs. 1,50,000/- from 8th to 10th Direct.

Increase your weekly Maximum Eligible Commission by Rs.1,00,000/- Each from 11th & above direct..

1. When anyone from your 11th & above direct or anyone from his corresponding organizations (SAO & SGO) will achieve 15000 SP **ORGANIZATIONS** equivalent in that week.

Any 11th Direct self or anyone from his corresponding organizations (SAO & SGO) will achieve 15000 SP in SAO & 15000 SP in SGO	Rs.100000/- will add to current Maximum Eligible Commission
Any 12th Direct self or anyone from his corresponding organizations (SAO & SGO) will achieve 15000 SP in SAO & 15000 SP in SGO	Rs.100000/- will add to current Maximum Eligible Commission
Any 13th Direct self or anyone from his corresponding organizations (SAO & SGO) will achieve 15000 SP in SAO & 15000 SP in SGO	Rs.100000/- will add to current Maximum Eligible Commission

Maximum Eligible Commission will increase up to Rs. 20,00,000/- from 11th & above Direct.

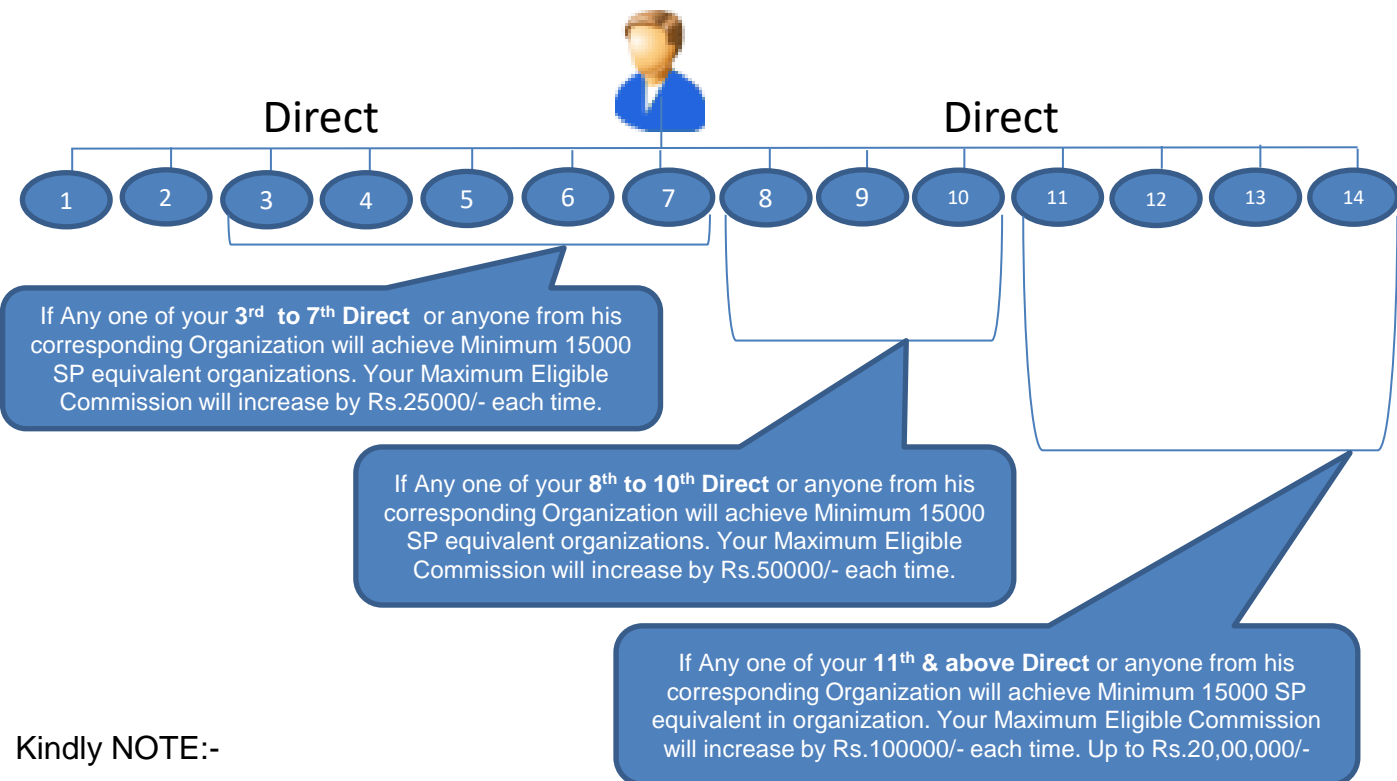

Kindly NOTE:-

- a. Maximum Eligible Commission will remain same in case of higher SP equivalent than 15000 SP as mentioned above.
- b. Up-gradation of **maximum eligible commission** is the way of growth in sales & weekly maximum eligible Commission limit to Direct Sellers.
- c. No Limit of sales organization.
- d. This criteria to increase Maximum Weekly sales commission is applicable for all three type of Direct Sellers.
- e. If any one of 3rd & above direct or his corresponding organizations will achieve Maximum eligible Commission. Then Maximum eligible commission limit will increase only single time on each criteria.

B. MONTHLY SALES PERFORMANCE COMMISSION

The company shall provide another commission in form of **Monthly SALES Performance Commission** as Rs.33.00 for each 1 SP on the achievement of specified purchase/sale by the direct seller in corresponding organizations as mentioned below -

DIRECT SELLER –A



S.A.O = 200 SP & S.G.O = 100 SP

Qualified For

BRONZE DS
1st RANK

DIRECT SELLER –B



S.A.O = 600 SP & S.G.O = 300 SP

Qualified For

SILVER DS
2nd RANK

DIRECT SELLER –C

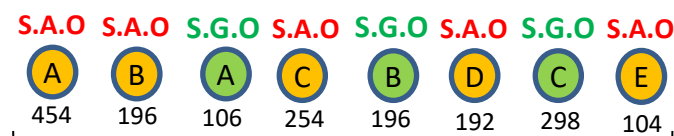

S.A.O = 1200 SP & S.G.O = 600 SP

Qualified For

GOLD DS
3rd RANK

DIRECT SELLER –D



S.A.O = 2400 SP & S.G.O = 1200 SP

Qualified For

PLATINUM DS
4TH RANK

DIRECT SELLER –E



S.A.O = 4800 SP & S.G.O = 2400 SP

Qualified For

EMERALD DS
5TH RANK

DIRECT SELLER –F

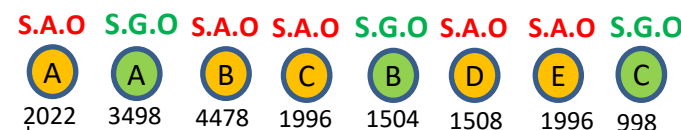

S.A.O = 12000 SP & S.G.O = 6000 SP

Qualified For

TOPAZ DS
6TH RANK

DIRECT SELLER –G



S.A.O = 24000 SP & S.G.O= 12000 SP

Qualified For **RUBY STAR DS**
7TH RANK

DIRECT SELLER –H



S.A.O = 48000 SP & S.G.O= 24000 SP

Qualified For **SAPPHIRE DS**
8TH RANK

Kindly Note :-

- Sales Point shown in above Diagrams are total of Respective Direct Seller corresponding Organizations.
- To achieve any Rank, each individual must have to make new purchases/sale in corresponding organizations as per sales point shown for that rank. SP of previous rank will not be valid in any new rank.

Such Monthly Sales Performance Commission will be distributed as per below mentioned percentage of Monthly Sales Performance Commission as calculated below :-

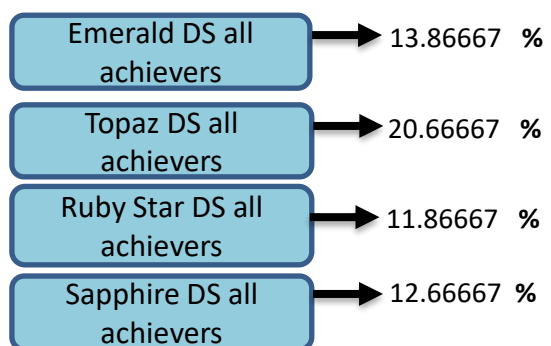
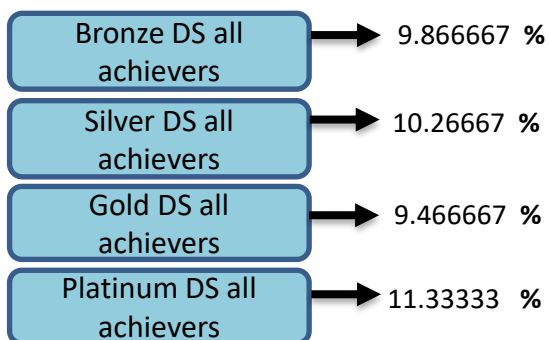

KINDLY NOTE THAT

1. In Monthly Sales Performance Commission, Company shall distribute Rs.33.00 for each 1 SP as explained below.
2. 1st to 8th Rank **Monthly sales Performance Commission** shall be calculated and distributed among all achieved of 1st to 8th Rank on monthly basis with % of Rs.33.00
3. To consider the Rank to receive **Monthly sales Performance Commission** it shall be calculated on the basis of sales point accumulated in corresponding organizations on monthly basis as per mentioned below.
4. To maintain & get such Monthly Sales Performance commission on regular basis a **self Purchase** of 5 SP from 1st to 5th Rank & 15 SP from 6th to 8th Rank Direct Sellers should be done on monthly basis.
5. **Monthly sales Performance Commission** would be calculated on the monthly basis i.e. at the end of each month.
6. If the achievers of such commission in particular category is more than one than the company shall distributed such commission in all achievers equally as mentioned in the example at below.
7. The company shall provide maximum **Monthly sales Performance Commission** as below mentioned prescribed limit.

S.No.	Rank	Monthly sales Performance Commission
1	BRONZE DS all Achievers	9.866667 % of Monthly Sales Performance Commission as calculated above OR up to maximum prescribed limit of Rs.1500/- whichever is lower
2	SILVER DS all Achievers	10.266667 % of Monthly Sales Performance Commission as calculated above OR up to maximum prescribed limit of Rs.4500/- whichever is lower.
3	GOLD DS all Achievers	9.466667 % of Monthly Sales Performance Commission as calculated above or up to maximum prescribed limit of Rs.9000/- whichever is lower.
4	PLATINUM DS all Achievers	11.333333 % of Monthly Sales Performance Commission as calculated above or up to maximum prescribed limit of Rs.20000/- whichever is lower.
5	EMERALD DS all Achievers	13.866667 % of Monthly Sales Performance Commission as calculated above or up to maximum prescribed limit of Rs.45000/- whichever is lower.
6	TOPAZ DS all Achievers	20.666667 % of Monthly Sales Performance Commission as calculated above or up to maximum prescribed limit of Rs.150000/- whichever is lower. And Trip to Thailand 3N/4D (Self)
7	RUBY STAR DS all Achievers	11.866667 % of Monthly Sales Performance Commission as calculated above or up to maximum prescribed limit of Rs.230000/- Whichever is lower.
8	SAPPHIRE DS all Achievers	12.666667 % of Monthly Sales Performance Commission as calculated above or Up to maximum prescribed limit of Rs.360000/- Whichever is lower. And Trip to Dubai 3N/4D (Couple + 2 Children)

NOTE : Above mentioned trips destinations may be changed as per company discretion.

FORMULA OF CALCULATION- Monthly Sales Performance Commission

1. Monthly Sales Performance Commission (1st to 8th Rank).

Suppose,

Monthly Total S.P Turnover of Company = 20,00,000 SP

Distribution @ Rs.33 per S.P = Rs.33 × 2000000 SP = Rs.6,60,00,000 /- (Will be distributed as per % of rank wise)

Example For Bronze Rank, Total Achievers = 4210

$$\text{Fund for Distribution} = \text{Rs. } 6,60,00,000 \times \frac{9.866667}{100} = \text{Rs. } 65,12,000 /-$$

$$\text{Monthly Sales Commission Rate (MSCR)} = \frac{65,12,000}{4210} = \text{Rs. } 1546.79 /- \text{ (Each will get Rs.1500/- up to maximum prescribed limit)}$$

Example For Ruby Star Rank, Total Achievers = 32

$$\text{Fund for Distribution} = \text{Rs. } 6,60,00,000 \times \frac{11.866667}{100} = \text{Rs. } 7832002 /-$$

$$\text{Monthly Sales Commission rate (MSCR)} = \text{Rs. } \frac{7832002}{32} = \text{Rs. } 2,44,750 /- \text{ (Each will get Rs.230000/- up to maximum prescribed limit)}$$

C. STAR SALES LEADERSHIP COMMISSION

The company shall provide another commission in form of **Star Sales Leadership Commission** as Rs.15.00 for each 1 SP on the achievement of specified purchase/sale by the direct seller in corresponding organizations as mentioned below -

DIRECT SELLER -A

S.A.O	S.G.O	S.A.O	S.A.O	S.G.O	S.A.O	S.A.O	S.G.O	S.A.O	S.A.O	S.G.O
A	A	B	C	B	D	E	C	F	G	D
9478	22356	10522	25024	13046	23976	12012	7678	14086	902	4920

S.A.O = 96000 SP & S.G.O= 48000 SP

Qualified For
STAR SAPPHIRE DS

DIRECT SELLER -B

S.A.O	S.G.O	S.A.O	S.A.O	S.G.O	S.A.O	S.A.O	S.G.O	S.G.O	S.A.O	S.A.O
A	A	B	C	B	D	E	C	D	F	G
25456	24356	23678	45346	24440	34876	31567	31245	15959	21567	9510

S.A.O = 192000 SP & S.G.O= 96000 SP

Qualified For
DIAMOND DS

DIRECT SELLER -C

S.A.O	S.G.O	S.A.O	S.A.O	S.G.O	S.A.O	S.A.O	S.G.O	S.G.O	S.A.O	S.G.O	S.A.O
A	A	B	C	B	D	E	C	D	F	E	G
28678	46568	45678	56765	51436	61453	45367	34865	26545	65876	32586	80183

S.A.O = 384000 SP & S.G.O= 192000 SP

Qualified For
BLUE DIAMOND DS

DIRECT SELLER -D

S.A.O	S.G.O	S.A.O	S.A.O	S.G.O	S.A.O	S.A.O	S.G.O	S.A.O	S.A.O	S.G.O	S.A.O	S.A.O	S.G.O
A	A	B	C	B	D	E	C	F	G	D	H	I	E
56453	45678	63987	71654	74567	85456	121345	96754	110345	109765	121876	125433	23562	45125

S.A.O = 768000 SP & S.G.O= 384000 SP

Qualified For
BLACK DIAMOND DS

DIRECT SELLER -E

S.A.O	S.G.O	S.A.O	S.A.O	S.G.O	S.A.O	S.A.O	S.G.O	S.A.O	S.A.O	S.G.O	S.A.O	S.A.O	S.G.O	S.A.O
A	A	B	C	B	D	E	C	F	G	D	H	I	E	J
252342	146785	210245	350600	158163	198564	121345	196751	110345	109765	121176	82830	43532	145125	56432

S.A.O = 1536000 SP & S.G.O= 768000 SP

Qualified For
ROYAL DIAMOND DS

DIRECT SELLER -F

S.A.O	S.G.O	S.A.O	S.A.O	S.G.O	S.A.O	S.A.O	S.G.O	S.A.O	S.A.O	S.G.O	S.A.O	S.A.O	S.G.O	S.A.O
A	A	B	C	B	D	E	C	F	G	D	H	I	E	J
576450	278580	256789	654390	445300	450345	320220	554345	206264	210987	131245	120560	165680	126530	110315

S.A.O = 3072000 SP & S.G.O= 1536000 SP

Qualified For
CROWN DIAMOND DS

Such Star Sales Leadership Commission shall be distributed as per below mentioned percentage Of Sales Leadership Commission as calculated below :-

TABLE –B

Below mentioned minimum SP every month to qualify in Star Sales Leadership Commission

		Sales Point in S.A.O	Sales Point in S.G.O
Star Sapphire DS All achievers	23.20 %	500 SP	500 SP
Diamond DS all achievers	18.3 %	1000 SP	1000 SP
Blue Diamond DS all achievers	17 %	1500 SP	1500 SP
Black Diamond DS all achievers	14 %	2000 SP	2000 SP
Royal Diamond DS all achievers	13.5 %	2500 SP	2500 SP
Crown Diamond DS all achievers	14 %	3000 SP	3000 SP

KINDLY NOTE THAT

1. In **Star Sales Leadership Commission**, company shall distribute Rs.15.00 for 1 SP as explained in the below example.
2. 9th to 14th Rank **Star Sales Leadership Commission** shall be calculated and distributed among all achieved 9th to 14th Rank on monthly basis with in the maximum limit of twelve months in partly basis as mentioned below % of Rs.15.00 till the realization of the maximum prescribed limit.
3. To consider the Rank to receive **Star Sales Leadership Commission**. It shall be calculated on the basis of sales point accumulated in corresponding organizations on monthly basis as per above Diagrams.
4. To maintain & get such commission on regular basis a **Self Purchase** of 45 SP per month should be done by Star Sapphire & above Rank Direct Sellers.
5. Direct Seller shall have the right to receive **Star Sales Leadership Commission** when direct seller maintain Minimum SALES as indicated in **(Table B)** on month to month basis.
6. If anyone has missed/skipped the criteria mentioned in Table – B during the month then maximum prescribed limit shall be reduced by that month percentage amount.
7. Star Sales Leadership Commission would be calculated on the monthly basis i.e. at the end of each month.
8. If the achievers of such commission in particular category is more than one than the company shall distributed such commission in all achievers equally as mentioned in the example at below.
9. The company shall provide maximum Star Sales Leadership Commission as below mentioned prescribed limit -

S.No.	Rank	Star Sales Leadership Commission :-
1	STAR SAPPHIRE DS all achievers	23.20 % of Star Sales Leadership Commission as calculated below or up to maximum prescribed limit of Rs.8,20,000/- whichever is lower. And Trip to Malaysia 3N/4D (Self)
2	DIAMOND DS all achievers	18.3 % of Star Sales Leadership Commission as calculated below or up to maximum prescribed limit of Rs.12,40,000/- Whichever is lower. And Trip to Maldives 3N/4D (Couple)
3	BLUE DIAMOND DS all achievers	17 % of Star Sales Leadership Commission as calculated below or up to maximum prescribed limit of Rs.22,00,000/- whichever is lower. And Trip to Switzerland 5N/6D (Couple + 2 Children)
4	BLACK DIAMOND DS all achievers	14 % of Star Sales Leadership Commission as calculated below or up to maximum prescribed limit of Rs.35,00,000/- whichever is lower. And Trip to St. Petersburg Russia 4N/5D (Self)
5	ROYAL DIAMOND DS all achievers	13.5 % of Star Sales Leadership Commission as calculated below or up to maximum prescribed limit of Rs.59,00,000/- whichever is lower. And Trip to Singapore/Malaysia 5N/6D (Couple + 2 Children)
6	CROWN DIAMOND DS all achievers	14 % of Star Sales Leadership Commission as calculated below or up to maximum prescribed limit of Rs.93,00,000/- whichever is lower. And Trip to Moscow 4N/5D (Couple + 2 Children)

NOTE : Above mentioned trips destinations may be changed as per company discretion.

FORMULA OF CALCULATION for Star Sales Leadership Commission

Suppose,

1st Monthly Total S.P Turnover of Company = 2000000 SP

Distribution @ Rs. 15 per S.P = Rs.15 × 2000000 SP = Rs.3,00,00,000 /- (Will be distributed as per % of Rank wise)

Example For Star Sapphire, Total Achievers in 1st Month = 10

Fund for Distribution = Rs.3,00,00,000 × $\frac{23.20}{100}$ = Rs.69,60,000 /-

Monthly Sales Commission rate (MSCR) = $\frac{69,60,000}{10}$ = Rs. 6,96,000 /- (Each A to J will get Rs. 6,96,000/- up to maximum prescribed limit as shown in Table B-1)

Now, 2nd Month , Total S.P Turnover of Company = 2000000 SP

Total new Star Sapphire in 2nd Month = 10 (**Now, Total no. of star sapphire for distribution 10+10= 20**)

Fund for distribution = Rs.15 × 2000000 SP = Rs.3,00,00,000 × $\frac{23.20}{100}$ = Rs.69,60,000 /-

Monthly Sales Commission rate (MSCR) = $\frac{Rs.69,60,000}{20}$ = Rs.3,48,000 /- (Each A to J will get Rs.1,24,000 /- & K to T will get Rs.5,72,000 /- up to maximum prescribed limit as shown in Table B-1)

Now, 3rd Month , Total S.P Turnover of Company = 2000000 SP.

Total New Star Sapphire in 3rd Month = 10 (**Now, Total no. of star sapphire for distribution 10+10= 20**)

Fund for distribution = Rs.15 × 2000000 SP = Rs.3,00,00,000 × $\frac{23.20}{100}$ =Rs. 69,60,000/-

Monthly Sales Commission rate (MSCR) = $\frac{Rs.69,60,000}{20}$ = Rs. 3,48,000/- (But, K to T will get Rs.248000/- up to maximum prescribed limit & U to AD will get Rs.448000/- as shown in Table B-1)

TABLE –B1 FOR DISTRIBUTION (In Rupees)

Distribution	Achievers	1st Month	2nd Month	3rd Month	Maximum Limit	%
A to J completed in 2ND Month	A	696000	124000		820000	23.20%
	B	696000	124000		820000	23.20%
	C	696000	124000		820000	23.20%
	D	696000	124000		820000	23.20%
	E	696000	124000		820000	23.20%
	F	696000	124000		820000	23.20%
	G	696000	124000		820000	23.20%
	H	696000	124000		820000	23.20%
	I	696000	124000		820000	23.20%
	J	696000	124000		820000	23.20%
K to T completed in 2ND Month	K		572000	248000	820000	23.20%
	L		572000	248000	820000	23.20%
	M		572000	248000	820000	23.20%
	N		572000	248000	820000	23.20%
	O		572000	248000	820000	23.20%
	P		572000	248000	820000	23.20%
	Q		572000	248000	820000	23.20%
	R		572000	248000	820000	23.20%
	S		572000	248000	820000	23.20%
	T		572000	248000	820000	23.20%
	U			448000	820000	23.20%
	V			448000	820000	23.20%
	W			448000	820000	23.20%
	X			448000	820000	23.20%
	Y			448000	820000	23.20%
	Z			448000	820000	23.20%
	AA			448000	820000	23.20%
	AB			448000	820000	23.20%
	AC			448000	820000	23.20%
	AD			448000	820000	23.20%

NOTE : Fund will be calculated & distributed as subjected to the maximum prescribe limit among all achievers.

D. AMBASSADOR CLUB LEADERSHIP COMMISSION The company shall provide another commission in form of AMBASSADOR CLUB LEADERSHIP COMMISSION as Rs. 7.00 for each 1 SP on the achievement of specified purchase/sale by the direct seller as below -

DIRECT SELLER –A

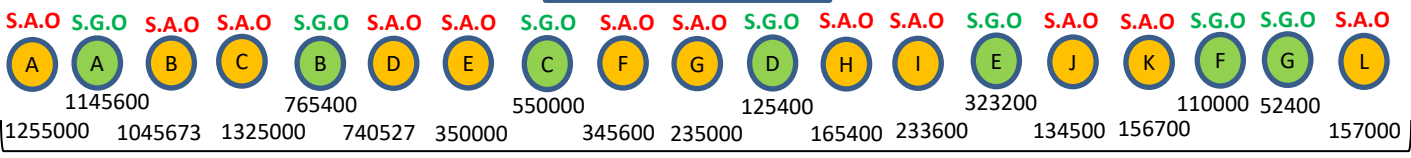

S.A.O = 6144000 SP & S.G.O= 3072000 SP

**Qualified For
AMBASSADOR DS**

DIRECT SELLER –B

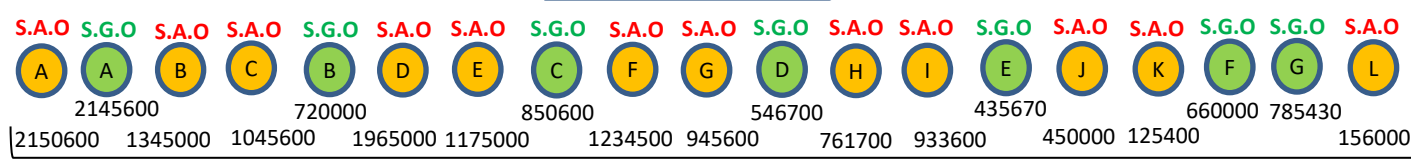

S.A.O = 12288000 SP & S.G.O= 6144000 SP

**Qualified For
ROYAL AMBASSADOR DS**

DIRECT SELLER –C

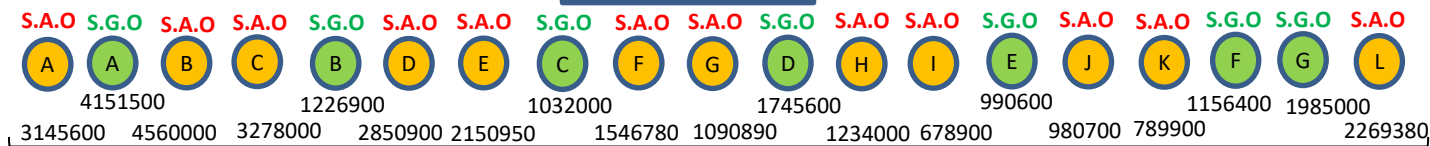

Qualified For

S.A.O = 24576000 SP & S.G.O= 12288000 SP

CROWN AMBASSADOR DS

DIRECT SELLER –D

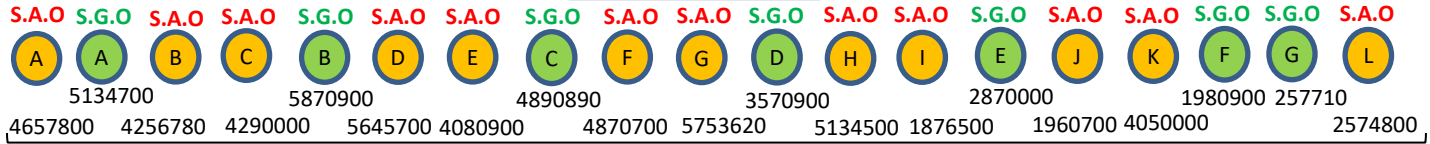

Qualified For

S.A.O = 49152000 SP & S.G.O= 24576000 SP

BRAND AMBASSADOR DS

Such Ambassador Club Leadership Commission will be distributed as per below mentioned percentage of Ambassador Club Leadership Commission calculated as below :-

TABLE – C

Fresh SP in every month to qualify in AMBASSADOR CLUB LEADERSHIP COMMISSION

		Fresh Sales Point in S.A.O	Fresh Sales Point in S.G.O
Ambassador DS all achievers	32.15 %	5000 SP	5000 SP
Royal Ambassador DS all achievers	25 %	7500 SP	7500 SP
Crown Ambassador DS all achievers	25 %	10000 SP	10000 SP
Brand Ambassador DS all achievers	17.85%	15000 SP	15000 SP

KINDLY NOTE THAT

- In Ambassador Club Leadership Commission, company shall provide Rs.7.00 for 1 SP as explained in below example.
- 15th to 18th Rank Ambassador Club Leadership Commission shall be calculated on monthly basis and distributed among all achieved 15th to 18th Rank on the basis of company monthly sales point turnover up to maximum prescribed limit in partly basis as below specified % of Rs 7.00 till the realization of the maximum prescribed limit.**
- To consider the Rank to receive **Ambassador Club Leadership Commission**. It shall be calculated on the basis of sales point accumulated in corresponding organizations on monthly basis as per above Diagrams..
- To maintain & get such commission on regular basis a **Self Purchase** of 45 SP per month should be done by Ambassador & above Rank Direct Sellers.
- Direct Seller shall have the right to receive Ambassador Club Leadership Commission when direct seller maintain Minimum SALES as indicated in above (**Table C**) on month to month basis.
- If anyone has missed/skipped the criteria mentioned in Table-C during the month then maximum prescribed limit shall be reduced by that month percentage amount.
- Ambassador Club Leadership Commission would be calculated on the monthly basis i.e. at the end of each month.
- If the achievers of such commission in particular category is more than one than the company shall distributed such commission in all achievers equally as mentioned in the example at below.
- The company shall provide maximum Ambassador Club Leadership Commission as below mentioned prescribed limit.

S.No.	Rank	Ambassador Club Leadership Commission
1	AMBASSADOR DS all achievers	32.15 % of Ambassador Club Leadership Commission as calculated above or up to maximum prescribed limit of Rs.15000000/- whichever is lower. And Trip to Australia 5N/6D (Self)
2	ROYAL AMBASSADOR DS all achievers	25 % of Ambassador Club Leadership Commission as calculated above or up to maximum prescribed limit of Rs. 28500000/- Whichever is lower.
3	CROWN AMBASSADOR DS all achievers	25 % of Ambassador Club Leadership Commission as calculated above or up to maximum prescribed limit of Rs.55000000/- whichever is lower.
4	BRAND AMBASSADOR DS all achievers	17.85 % of Ambassador Club Leadership Commission as calculated above or up to maximum prescribed limit of Rs. 120000000/- whichever is lower. And Trip to Australia 5N/6D(Couple + 2 Children)

NOTE : Above mentioned trips destinations may be changed as per company discretion.

FORMULA OF CALCULATION FOR AMBASSADOR CLUB LEADERSHIP COMMISSION

Suppose,

1st Month Total S.P Turnover of Company = 2000000 SP

Distribution @ Rs. 7 per S.P = Rs.7 × 2000000 SP = Rs.14000000 /- (Will be distributed as per % of Rank wise)

Example For Ambassador, Total Achiever in 1 Month = 1 (A)

Fund for Distribution = Rs.14000000 × $\frac{32.15}{100}$ = Rs. 45,01,000 /-

MSCR = $\frac{Rs.45,01,000}{1}$ = Rs. 45,01,000 /- (Will be distributed to A in 1st Month as shown in Table B-1)

2nd Month Total S.P Turnover of Company = 2000000 SP

Distribution @ Rs.7 per S.P =Rs.7 × 2000000 SP = Rs.14000000 /- (Will be distributed as per % of Rank wise)

Example For Ambassador, Total Achievers from last month = 1 (A) + New Achiever 1(B)

Fund for Distribution = Rs.14000000 × $\frac{32.15}{100}$ = Rs.45,01,000/-

MSCR = $\frac{Rs.45,01,000}{2}$ = Rs.22,50,500 /- (Will be distributed to A & B in 2nd Month as shown in Table B-1)

3rd Month Total S.P Turnover of Company = 2000000 SP

Distribution @ Rs.7 per S.P = Rs.7 × 2000000 SP = Rs. 14000000 /- (Will be distributed as per % of Rank wise)

Example For Ambassador, Total Achievers from last month = 1 (A) + B + (C) 1 new achiever = Total 3

Fund for Distribution = Rs.14000000 × $\frac{32.15}{100}$ = Rs. 45,01,000/-

MSCR = $\frac{Rs.45,01,000}{3}$ = Rs.15,00,333 /- (Will be distributed to A ,B & C in 3rd Month as shown in Table B-1)

TABLE C-1 FOR DISTRIBUTION (In Rupees)

Achievers	1st Month	2nd Month	3rd Month	Maximum Limit	%
A	4501000	2250500	1500333	15000000	32.15%
B		2250500	1500333	15000000	32.15%
C			1500333	15000000	32.15%

(Ambassador Club Leadership Commission distribution shall be in partly basis up to maximum prescribed limit as per company Purchase Sales point turnover)

E. PREMIUM STAR SALES PERFORMANCE COMMISSION

The company shall provide another sales commission in form of **PREMIUM STAR SALES PERFORMANCE COMMISSION** in which company is distributing 1.00 Rs. for 1 SP.

Example :-

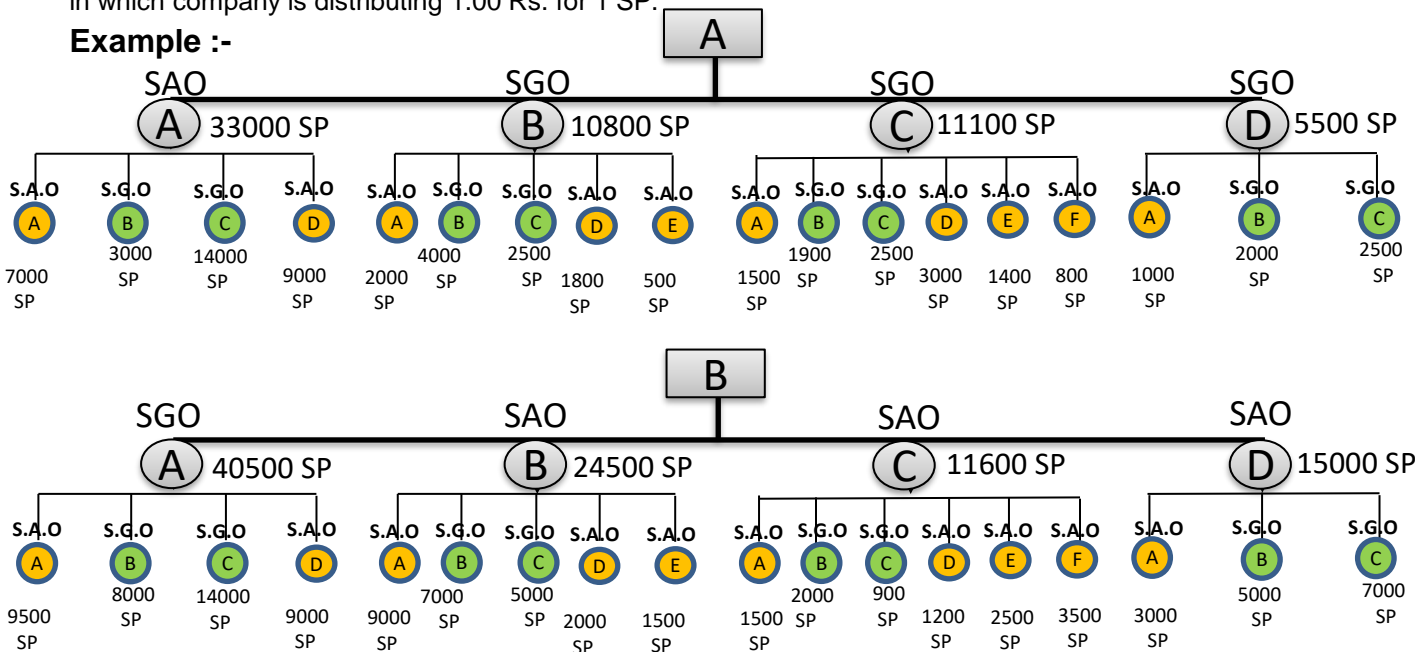

From above mentioned Example:

A Total sales SP from SAO = 33,000 SP ;

A Total sales SP from SGO = 27,400 SP ;

B Total sales SP from SAO = 51,100 SP

B Total sales SP from SGO = 40,500 SP

For A, EQUIVALENT SP is = 27,400 SP

For B, EQUIVALENT SP is = 40,500 SP

BUT, 15,000 SP is already used in Premium Direct Seller maximum Eligible Commission of that week from corresponding organizations i.e. (SAO & SGO).

For A, eligible SP for PREMIUM STAR SALES PERFORMANCE COMMISSION = 27,400 – 15,000 SP = 12,400 SP

For B, eligible SP for PREMIUM STAR SALES PERFORMANCE COMMISSION = 40,500 – 15,000 SP = 25,500 SP

FORMULA OF CALCULATION FOR PREMIUM STAR SALES PERFORMANCE COMMISSION

$$\frac{\text{Total company SP turnover in that week} \times 1.00 \text{ Rs.}}{\text{Total Premium Direct Seller equivalent SP after Maximum eligible Sales Commission of that week}} = \text{PREMIUM STAR SALES PERFORMANCE COMMISSION RATE}$$

For Example :-

Total S.P turnover in week = 500,000 SP

Total Premium Direct Seller equivalent cycle after Maximum eligible Commission of that week = 37,900 SP

Now, 500,000 SP × 1Rs. = Rs. 500,000.00

$$\frac{500,000 \text{ SP} \times 1 \text{ Rs.}}{37,900} = 13.1926 \text{ Rs. (Premium Star Sales Performance Commission Rate)}$$

Now, Premium Star Sales Performance Commission for A :- 12,400 × 13.19 = Rs. 1,63,588.00

Premium Star Sales Performance Commission for B :- 25,500 × 13.19 = Rs. 3,36,411.00

Kindly Note that –

- The calculation for the PREMIUM STAR SALES PERFORMANCE COMMISSION will be on weekly basis.
- This type of commission is applicable for only Premium Direct Seller category. Executive & Super Direct Seller category is not eligible for this commission. (Category is already mentioned in Table-A)
- Weekly Maximum eligibility limit for PREMIUM STAR SALES PERFORMANCE COMMISSION is Rs.600,000.00 for each Premium Star Direct Seller.
- Premium Star Direct Seller Means: One who qualifies the maximum eligible sales growth commission from corresponding sales organizations with equivalent 15,000 SP.
- To Calculate Premium Star Sales Performance Commission already achieved Sales Growth Commission of Rs. 1,50,000.00 or 15,000 SP in corresponding organization shall be deducted.
- If the achievers of such commission in particular category is more than one then the company shall distribute such commission in all achievers equally as mentioned in above example.

F. 3RD AND ABOVE DIRECT LEG SALES INCENTIVE

The company shall provide another commission in form of **3RD AND ABOVE DIRECT LEG SALES INCENTIVE** in which company is distributing 1.00 Rs. for 1 SP.

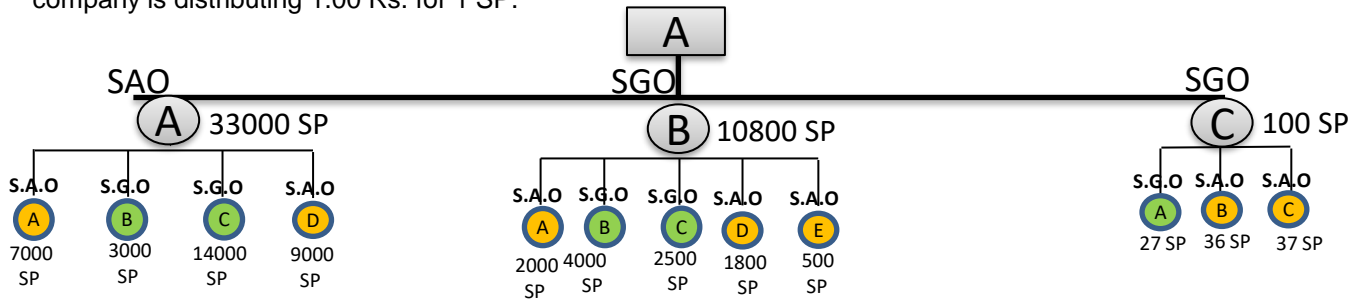

A Total sales SP from SAO 1st Direct = 33000 SP

A Total sales SP from SGO 2nd Direct = 10800 SP

A Total sales SP from SGO 3rd Direct = 100 SP

For A, eligible SP from 3rd & above Direct Leg = 100 SP

Suppose, Qualified Direct Sellers from 3rd & above Direct Legs with 100 SP = 412.

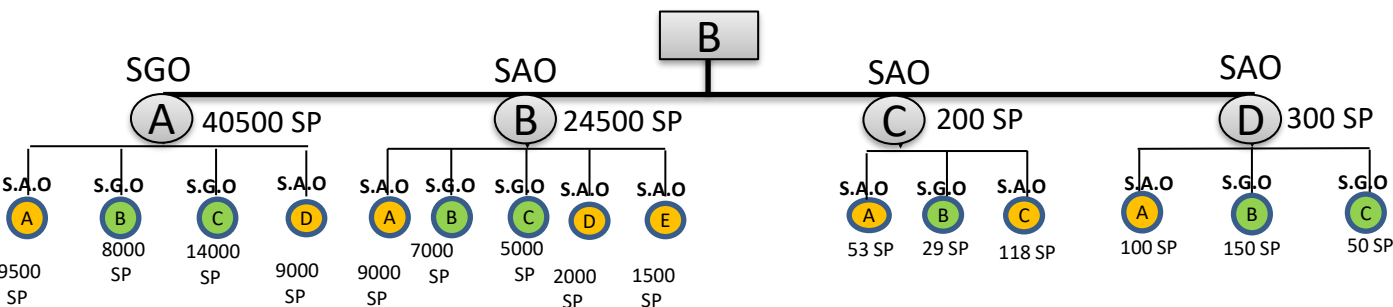

B Total sales SP from SGO 1st Direct = 40500 SP

B Total sales SP from SAO 2nd Direct = 24500 SP

B Total sales SP from SAO 3rd Direct = 200 SP

B Total sales SP from SAO 4th Direct = 300 SP

For B, eligible SP from 3rd & above Direct Legs = 500 SP

Suppose, Qualified Direct Sellers from 3rd & above Direct Legs with 500 SP = 120.

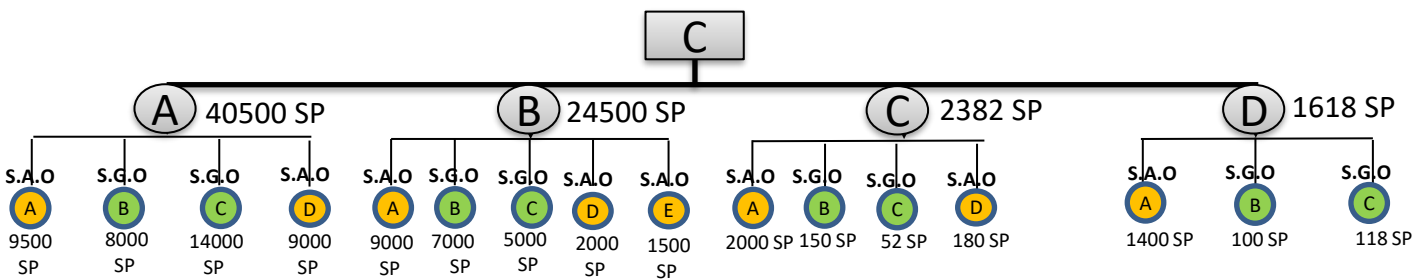

C Total sales SP from SGO 1st Direct = 40500 SP

C Total sales SP from SAO 2nd Direct = 24500 SP

C Total sales SP from SAO 3rd Direct = 2382 SP

C Total sales SP from SAO 4th Direct = 1618 SP

For C, eligible SP from 3rd & above Direct Legs = 4000 SP

Suppose, Qualified Direct Sellers from 3rd & above Direct Legs with 4000 SP = 8.

FORMULA OF CALCULATION FOR 3RD AND ABOVE DIRECT LEG SALES INCENTIVE

Total company SP turnover in that month × 1.00 Rs.

3RD AND ABOVE DIRECT LEG SALES INCENTIVE RATE

100 SP & above sales by Direct Sellers in that month from

Total S.P turnover in that month = 2000000 SP
100 SP & above sales by Direct Sellers in that month from 3rd & above Direct Legs = 133333 SP

$2000000 \text{ SP} \times 1 \text{ Rs} = \frac{\text{Rs. } 2000000}{133333} = \text{Rs. } 15.00 \text{ Rs. (3RD \& ABOVE DIRECT LEG SALES INCENTIVE RATE)}$

Now, For **A 3rd AND ABOVE DIRECT LEG SALES INCENTIVE** = $100 \times 15 = \text{Rs. } 1500.00$

Similarly, Total Direct Sellers achieved in that month = 412 = $412 \times 1500.00 = \text{Rs. } 618000.00$

Now, For **B 3rd AND ABOVE DIRECT LEG SALES INCENTIVE** = $500 \times 15 = \text{Rs. } 7500.00$

Similarly, Total Direct Sellers achieved in that month = 120 = $120 \times 7500.00 = \text{Rs. } 900000.00$

Now, For **C 3rd AND ABOVE DIRECT LEG SALES INCENTIVE** = $4000 \times 15 = \text{Rs. } 60000.00$

Similarly, Total Direct Sellers achieved in that month = 8 = $8 \times 60000.00 = \text{Rs. } 480000.00$

Kindly Note that –

1. The calculation for **3RD AND ABOVE DIRECT LEG SALES INCENTIVE** will be on monthly basis.
2. **3rd & Above Direct Sales Promotion Commission** is applicable only when any Direct seller is having **3rd or more SAO / SGO** in corresponding organization with purchase/sale of **100 SP & above** in that month.
3. Monthly maximum eligibility limit for **3RD AND ABOVE DIRECT LEG SALES INCENTIVE** is **Rs.60000.00** for each Direct Seller in that month.

F. PREFERRED CONSUMER SALES COMMISSION

The company shall provide another sales commission in form of **PREFERRED CONSUMER SALES COMMISSION** on below mentioned terms & Criteria:-

1. Each Direct Seller will get a unique Preferred consumer code & eligible to get this Commission.
2. Preferred consumer will get **10% discount** on MRP if purchase product by putting any **Preferred Customer** code as given by Direct Sellers.
3. Direct Seller will get **10% amount** of product MRP as **PREFERRED CONSUMER SALES COMMISSION** which is purchased by consumer by putting his **Preferred Consumer** code.
4. All SP accumulated by **PREFERRED CONSUMER** purchased products will be added in corresponding organization of such Direct seller .
5. Preferred consumer shall not be considered as Direct Seller in any corresponding organization of Direct Seller.
6. If the achievers of such commission particular category is more than one then the company shall distribute such commission in all achievers equally as mentioned in above example.

Sales Growth Commission & Premium Star Sales Performance Commission will be closed weekly i.e. - (Thursday)

**Monthly Sales performance Commission, Star Sales Leadership Commission, Ambassador Club Leadership Commission, 3RD AND ABOVE DIRECT LEG SALES INCENTIVE & Preferred Consumer Sales Commission will be closed monthly i.e. - (Last date of every Month)
Deduction - TDS according to Income Tax Law.**

KINDLY NOTE :-

1. That, the above mentioned calculations of Overall S.P turnover of company. Commission will be given on Weekly / Monthly basis from Company which will be decided on the purchase/sale products SP Turnover of company as per above mentioned mathematical calculations.
2. That, this Amount is not Fixed, Guaranteed or Secured to the direct sellers in any aspect. It is exclusively, wholly & completely depend on the every week/month turnover of company S.P in proportion to the achieved sales by direct sellers.